

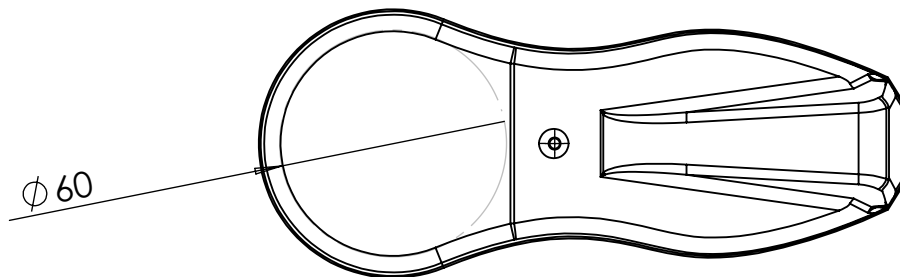

cierre de gabinete x1

SECCIÓN A-A

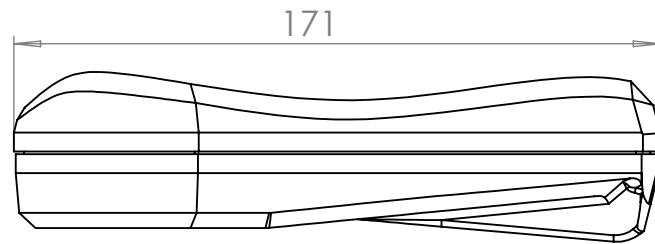
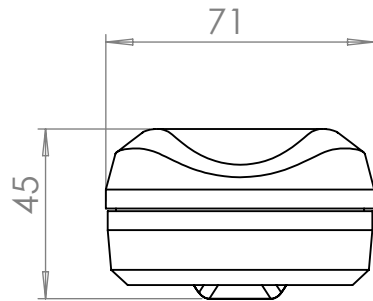
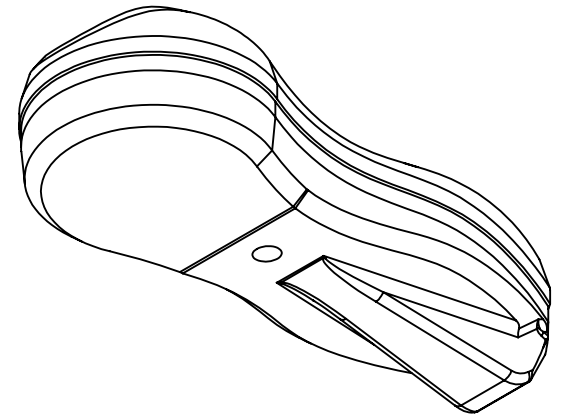
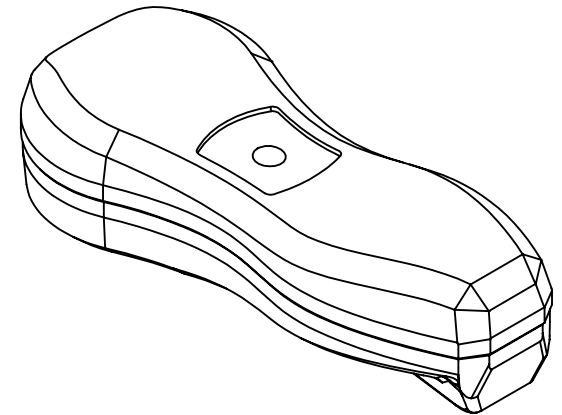
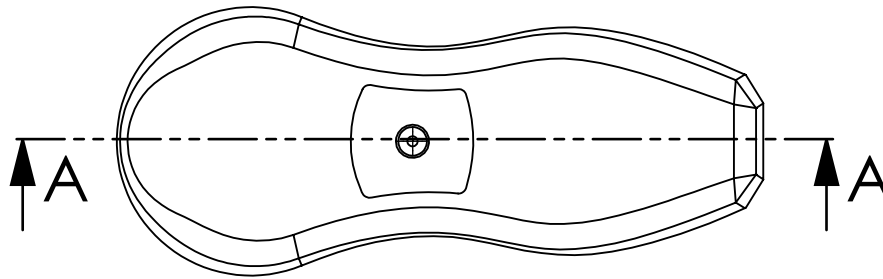

	Fecha	Nombre	Productos Termoformados	Color: Blanco
Dibujo				
Revisó				
Aprobó				
Esc.: 1:1				Terminación: Texturada mate
				<b>GABINETE ESTANDAR MANGO</b>
Tolerancia + 1 - 1	<a href="http://www.pro-te.com.ar">www.pro-te.com.ar</a> <a href="mailto:info@pro-te.com.ar">info@pro-te.com.ar</a>			Material: Poliestireno de Alto impacto de 3mm